



HAVELLS



Water Purifier

User Manual



STAINLESS STEEL
WATER TANK



TRIPLE
PROTECTION



ALKALINE
WATER
NATURE'S
WAY

GRACIA ALKALINE MAX
HOT | WARM | AMBIENT

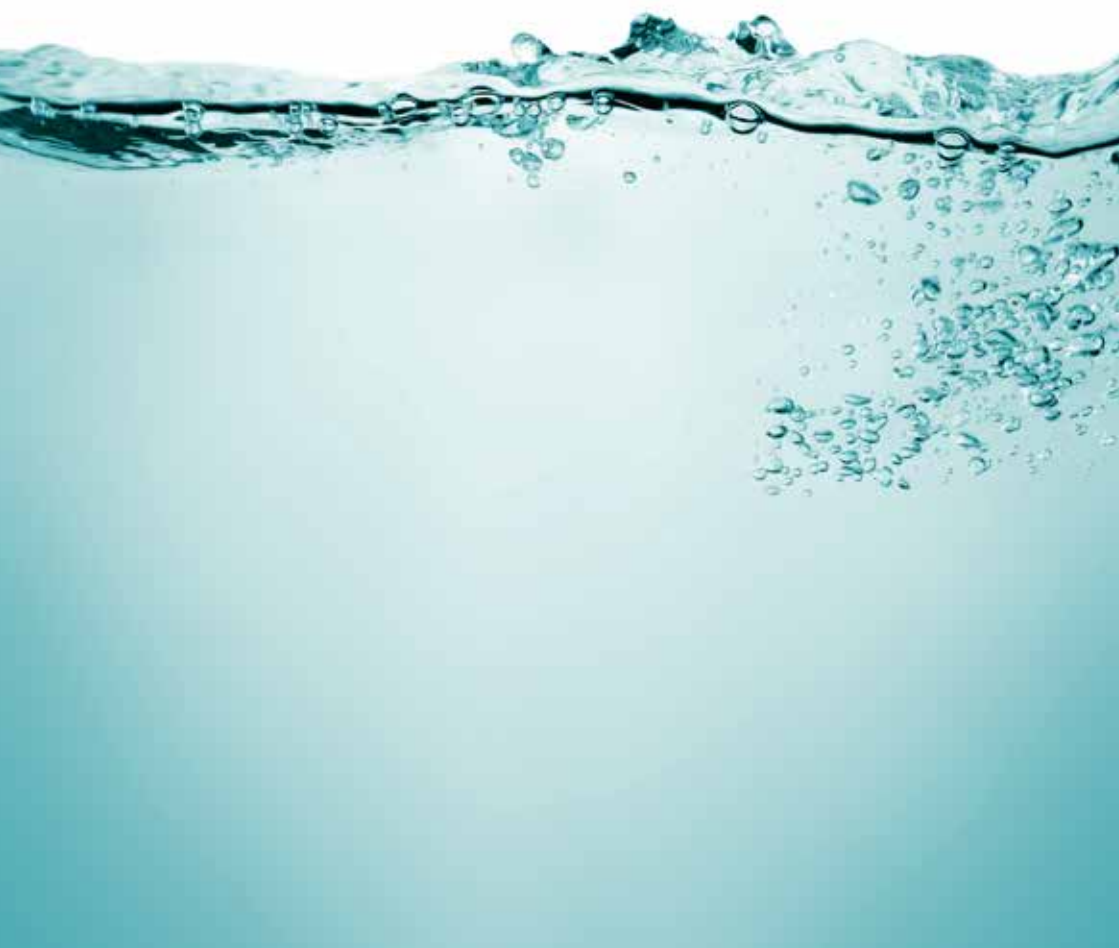

CONTENTS

Welcome to Havells water purifiers.....	2
Product overview.....	4
Technical specifications	5
Stages of purification	6
Water flow diagram.....	7
The purification process.....	8-9
Key features of Havells water purifier.....	10-11
Functions of smart indicators	12-17
Installation instructions	18
Do's, Don'ts & safety instructions	19
Safety Instructions	20
Cleaning and maintenance.....	21
Recommendations and important instructions.....	22
How to reuse the flushed water.....	23
Troubleshooting	23
FAQs	24-25
Warranty terms and conditions	26-27
Havells Customer Care.....	28
Warranty Card	29



HAVELLS

WELCOME TO HAVELLS WATER PURIFIERS

At Havells we believe in making a difference by touching every aspect of our consumers' lives through the products we make and bringing positive changes in it. Since the very beginning all our products have been manufactured keeping the highest standards of quality and innovation in mind and we make sure that they meet the world class standards that our consumers demand. And this legacy continues unwaveringly when it comes to Havells Water Purifiers too.

Our experts with decades of experience in Water Purification Technology have been listening to the consumers and we understand that due to lack of adequate information, there are a lot of questions and confusion in the consumers' minds about the need of water purifiers today and how to choose a water purifier basis the water quality in their area. Water quality has changed drastically over the years and many water purifiers available in the market today are not effective to give protection from the new age pollutants and provide safe drinking water devoid of any impurity.

Keeping this in mind, we have designed and perfected a water purifier that recognizes the challenges of new age pollutants and removes them effectively. What makes Havells Water Purifier unique is the fact that it has a powerful purification process to remove all complex impurities, adds back wide spectrum of naturally occurring essential minerals and trace elements that were removed in the filtration process and makes it easier to absorb and hydrates your body.

It is our commitment that we continuously strive to make lives better for our consumers, so let's understand your water purifier better in the subsequent sections.

Dear Customer,

We welcome you to the ever growing family of happy Havells consumers. Havells is being trusted by millions of consumers all over the world for its quality products and efficient after sales service.

It's a matter of great pride for us that you've entrusted Havells Water Purifier for your family and home. Our experts with decades of experience in Water Purification Technology have been listening to the consumers like you and have developed this purifier keeping in mind your needs and demanding lifestyle.

We are confident that you will be satisfied with its performance and it will fulfill your need for providing clean and safe drinking water to your loved ones.

This manual is a simple and easy to understand step by step guide that explains everything you need to know about your water purifier and it will assist you to get the best performance out of it. Please go through this booklet to understand its operation and periodic maintenance.

However in case you have any query or you need further assistance, please feel free to contact us at 08045 77 1313 or e-mail us your concerns or suggestions at customercare@havells.com

We thank you again for choosing Havells Water Purifier and assure you that your journey with us will be a delightful one.

Yours sincerely

Havells India Ltd.

PRODUCT OVERVIEW – GRACIA ALKALINE MAX

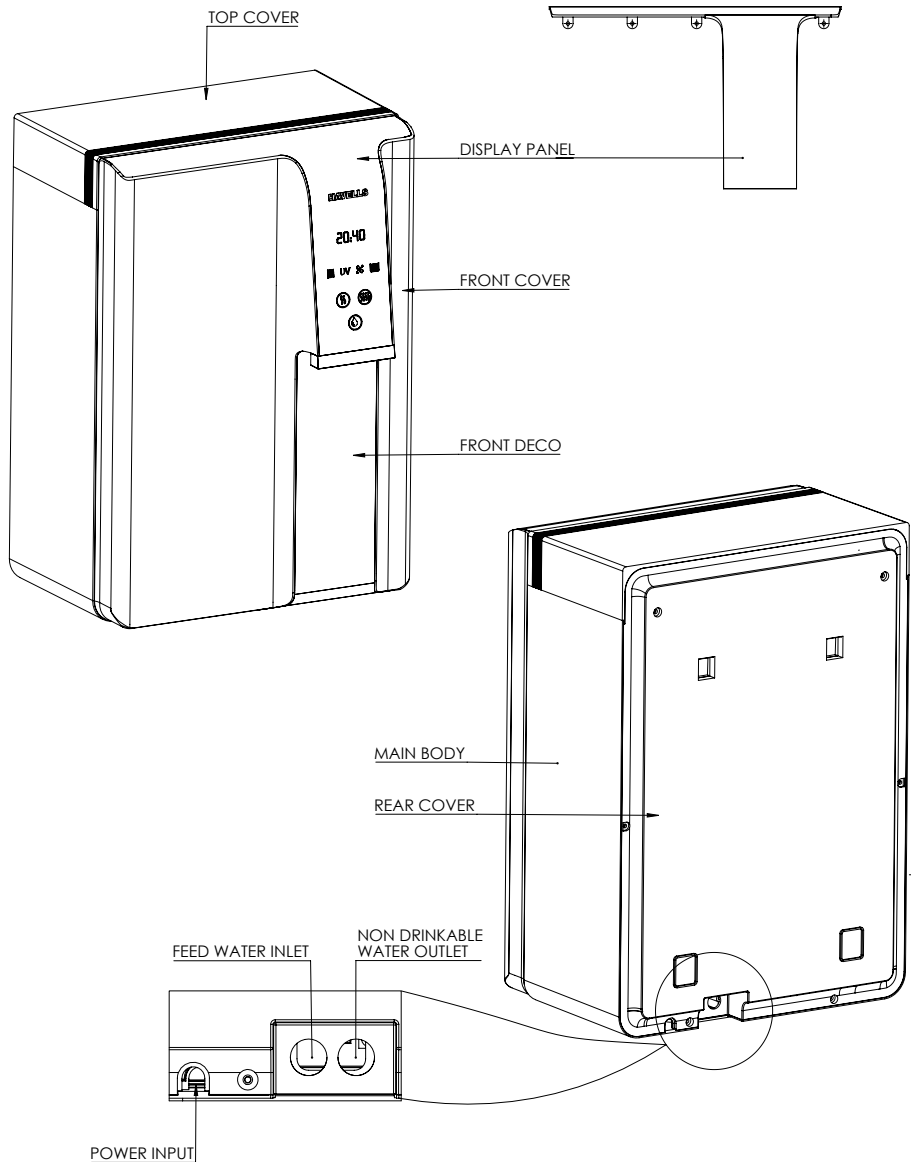

TECHNICAL SPECIFICATIONS-GRACIA ALKALINE MAX

PARAMETERS	VALUES
Product dimensions (L×W×H) in cm	(28.4 x 35.4 x 50) cm
Net weight	~ 12.8 kg
Flow rate*	Up to 15 L/h max.
Storage tank capacity	~ 6.8 L ± 300 ml
Storage tank capacity (Hot water tank)	~ 800 ml
Purification technology	Absolute safety through 100% RO & UV technology
Purification stages	7 Stages
Membrane type	Thin film composite RO membrane
Material of construction for plastic components	Food grade
Power rating (maximum)	60 W
Heating Element Wattage	500 W @ 230 V AC
Input voltage	230 V, 1 Phase AC, 50 Hz
TDS reduction**	≥ 90%
pH	8.5-10 (Slightly higher than drinking water standards)
System disinfection efficacy	6, 4, 3 Log reduction of bacteria, viruses & cysts at the rate of 30 L/h
Installation type	Wall mount & Counter top

RECOMMENDED FEED WATER QUALITY	
PARAMETERS	LIMITS
Total dissolved solids	Up to 2000 mg/L (ppm)
Total hardness	Up to 600 mg/L (ppm)
Turbidity ***	Up to 5 NTU
Feed water pressure****	0.04 MPa (6 psi) - 0.21 MPa (30 psi)
Feed water temperature	5 °C - 45 °C
Iron *****	Less than 0.3 mg/L (ppm)
Free chlorine	Less than 0.2 mg/L (ppm)

NOTE:

*Flow Rate may vary depending upon feed water quality, input water pressure, condition of membrane & cartridges

**TDS percentage reduction may vary depending upon type of feed water, feed water pressure & cartridges life

***In case, input turbidity is more than 5 NTU, you need to install pre filter at an additional cost.

****In case, input water pressure goes below 0.04 MPa (6 psi), you need to install external booster pump and if pressure is above

0.21 MPa (30 psi), you need to install pressure reducing valve at an additional cost

*****In case, the Iron content in input water is more than 0.3 mg/L (ppm), you need to install IRON X at an additional cost.

#The chemical preservative used in the RO membrane is of food grade quality.

STAGES OF PURIFICATION

GRACIA ALKALINE MAX

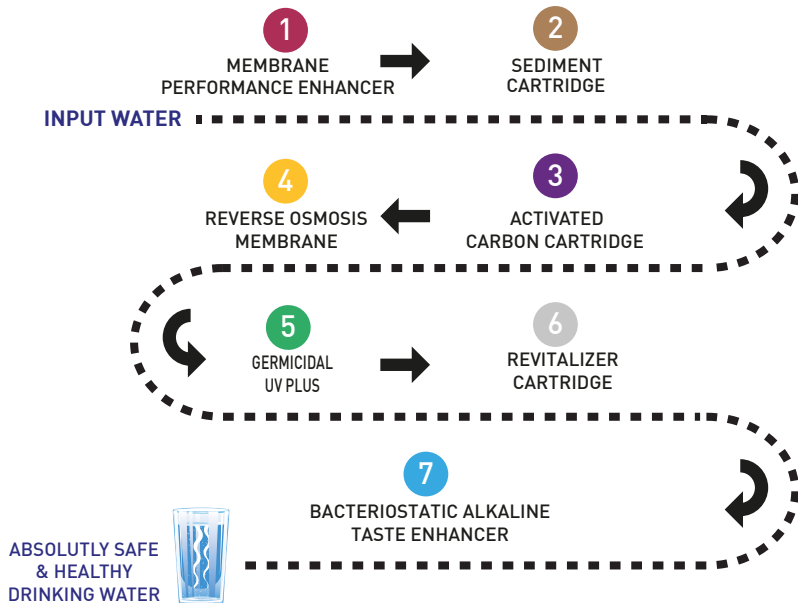

WATER FLOW DIAGRAM - GRACIA ALKALINE MAX

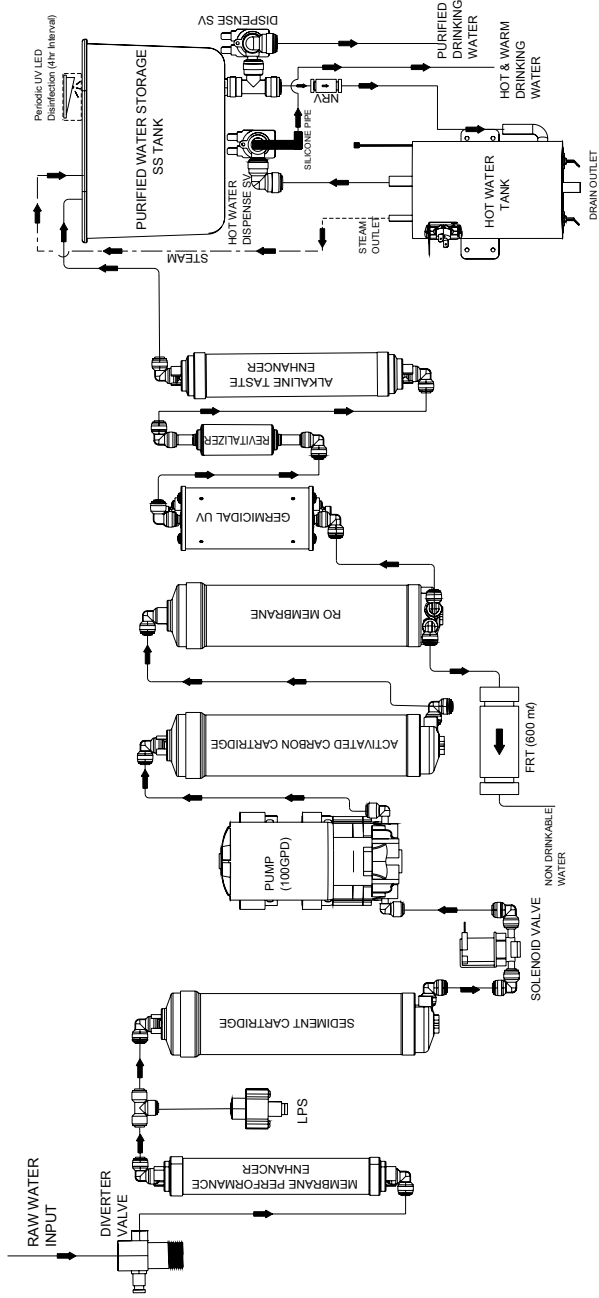

THE PURIFICATION PROCESS

Havells Water Purifiers have a powerful purification process which is divided into 3 Phases viz. Pre-Treatment, Purification & Value Additions. In pre-treatment process water will pass through Membrane Performance Enhancer, Sediment Filter and Activated Carbon Filter. During the purification process 100% water passes through RO Membrane followed by Germicidal UV disinfection column.

Water will pass through a controlled bipolar magnetic field which realigns the water molecules and make it better or more bioavailable and in the final stage of purification pH of water will be enhanced and minerals will be added to purified water. The names of all the cartridges along with their functions and benefits are explained in the table below for better understanding.

MEMBRANE PERFORMANCE ENHANCER

- 1 It prevents scaling formation on RO Membrane due to hardness in feed water, which results in improved performance and enhances the life of RO membrane.



SEDIMENT CARTRIDGE

- 2 Sediment Cartridge removes coarse and fine suspended impurities such as sand, silt, dust, clay, rust particles etc. from the feed water and makes it clear. This improves the performance and the life of activated carbon cartridge and the RO membrane.

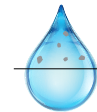

ACTIVATED CARBON CARTRIDGE

- 3 Activated Carbon, filter-cum-adsorber Cartridge removes a wide range of dissolved organic impurities like pesticides and herbicides along with residual chlorine and its by-products (THMs) present in the water. It also removes colour & objectionable odour from water. This in turn improves the taste of the water.



REVERSE OSMOSIS MEMBRANE

4

Reverse Osmosis Membrane removes dissolved contaminants such as dissolved solids, salinity, pesticides, herbicides as well as hazardous heavy metals like Arsenic, Chromium, Lead and Fluorides etc. It also removes harmful microbiological impurities such as bacteria, viruses and cysts from the feed water. It ensures absolutely safe and pure drinking water.



GERMICIDAL UV PLUS

5

An optimum exposure of water to germicidal UV-C radiation in UV disinfection column makes water free from microbiological threats like pathogenic bacteria & viruses.



REVITALIZER CARTRIDGE

6

Revitalizer Cartridge realigns the water molecules and makes it biologically active. It improves the hydration and mineral absorption in body



BACTERIOSTATIC ALKALINE TASTE ENHANCER

7

It enhance the pH of purified water by adding back wide spectrum of natural minerals & trace elements such as Calcium, Magnesium, Potassium, Sodium, Copper, Zinc, etc. It lowers the Oxidation Reduction Potential (ORP) resulting into anti-oxidant nature of water, transforms regular water into Alkaline Water, which is healthier & tastier.



PERIODIC DISINFECTION

8

24 x 7 tank sterilization UV LED prevents the Bio-film formation. Maintains hygiene of water and stainless steel tank.



KEY FEATURES OF HAVELLS WATER PURIFIER

TRIPLE PROTECTION: 100 % RO + GERMICIDAL UV COLUMN + UV LED PURIFICATION



Absolute Safety through 100% RO Purified Water:

100% Water passes through the RO Membrane to ensure absolutely safe and pure drinking water.



Purification through Germicidal UV Column :

An optimum exposure of water to germicidal UV-C radiation in UV Disinfection Column makes water free from microbiological threats like pathogenic bacteria and viruses.



24x7 Tank Sterlization:

UV LED prevents the Bio-film formation. Maintains hygiene of water and stainless steel tank.



BACTERIOSTATIC ALKALINE TASTE ENHANCER

It enhance the pH of purified water by adding back wide spectrum of natural minerals & trace elements such as Calcium, Magnesium, Potassium, Sodium, Copper, Zinc, etc. It lowers the Oxidation Reduction Potential (ORP) resulting into anti-oxidant nature of water, transforms regular water into Alkaline Water, which is healthier & tastier.



REVITALIZER CARTRIDGE

It realigns the water molecules and makes it biologically active. It improves the hydration and mineral absorption in body



TOUCH OPTION WITH DISPENSING OF HOT or WARM or AMBIENT WATER

Allows as per user demand hot water @ 80 °C or warm water @ 45 °C or ambient water @ room temperature with optimal dispense selection.



LED COLOUR TEMPERATURE GUIDE

Color temperature Red in appearance when warm water & hot water dispense and blue when ambient water dispense.



CONTEMPORARY DESIGN & AESTHETICS

Futuristic design, superior dual tone colour finish, compact design and functional display panel, compliment your kitchen décor.



AUTO DIAGNOSTIC

System diagnoses performance of vital components to ensure optimum performance and display error codes.



MAINTENANCE ALERTS

Timely alerts on preventive maintenance for the system.



CARTRIDGE LIFE INDICATOR

Monitors and displays the filter life expectancy to help you plan comprehensive maintenance in advance.



STAINLESS STEEL STORAGE TANK WITH INGRESS PROTECTION COVER

Best in class hygiene. Stops external invasion of insects and dust particles.



FUNCTIONS OF SMART INDICATORS



DIGITAL CLOCK DISPLAY

Switch ON your Gracia Water purifier, system will go in self check mode and all indications on display panel will glow for 5 seconds.

For clock setting, within first 5 seconds press warm and drop icon together. Touch Warm icon to decrement and Hot icon to increment the digit. Touch Drop icon to shift and again to set the time.

UV INDICATION

After 5 seconds self-test, UV disinfection will start & UV indication will start blinking. For next 30 seconds system will disinfect the stagnant water in UV column. Once disinfection cycle is over, system will start purifying water and filling purified water tank. During this period UV icon will glow solid.

TANK FULL INDICATOR

Once tank is full of water the system will stop and tank indicator glows solid.
If water is dispense from the system, the purification process will restart.

PERIODIC DISINFECTION

If water is not dispensed from the system for 4 hours, periodic UV sterilization cycle will start and the water stored in tank will be disinfected by exposing UV light for 10 minutes.

The periodic treatment process ensures safe drinking water and sterilised water storage tank at all times.

During this cycle, all indication will glow solid and "PtS" (Periodic tank Sterilization) message will be displayed.

WATER DISPENSING OPTIONS

The Dispensing touch is to start or stop the flow of filtered water by touching the drop icon.

Hot/Warm dispense option is allowed only once tank is full. On every power ON USER NEED TO SELECT heating mode (Hot/Warm) based on consumer REQUIREMENT.

This purifier is capable of dispensing warm water (45 °C) and hot water (80 °C) as per consumer's need.

The user can turn off the heater at any point with only pressing the drop icon until the 5 beep sounds.

FILTER LIFE

Your Filters life is counted, on the basis of the usage. One by one the bars of filter life indication will turn off with reducing life. A message 'CnGF' will appear on the clock and BEEP SOUND at an interval of 10 seconds. This is the time to replace your filters.







PREVENTIVE MAINTENANCE

After every 6 months if preventive maintenance is not attended in time, the service indication will start blinking and a message 'PSEr' will appear on the clock for 2 seconds at an interval of 10 seconds.





Please call Havells Service to attend the machine for preventive maintenance.



To select Warm water dispense option: (Warm water set temperature is 45 °C)

Step	Pictorial	Process
1.		<p>Touch and hold WARM icon for 3 seconds to turn ON heating water.</p>
2.		<p>During water heating process, WARM icon intensity will be increasing and decreasing. When temperature reached 45 °C, WARM icon will be solid ON with a long beep indicating ready to dispense warm water.</p>
3.		<p>Touch and hold WARM icon for 1 second. Warm water dispense will stop automatically after 1 minute of dispense or else touch any key to stop water dispensing manually.</p>
4.		<p>If warm water is not dispensed for more than 30 minutes heater will go off, if WARM icon go dim. Again, consumer need to touch and hold WARM icon for 3 seconds to turn ON water heating.</p>
<p>Segment display will show water temperature.</p>		

To select Hot water dispense option: (Hot water set temperature is 80 °C)

Step	Pictorial	Process
1.		Touch and hold HOT icon for 3 seconds to turn ON heating water.
2.		During water heating process, HOT icon intensity will be increasing and decreasing. When temperature reached 80 °C, HOT icon will be solid ON with a long beep indicating ready to dispense hot water
3.		Touch and hold Hot icon for 1 second. Hot water dispense will stop automatically after 1 minute of dispense or else touch any key to stop water dispensing manually.
4.		Touch and hold HOT and WARM icon all together for 3 seconds, then single beep will come indicating product entered to ready to dispense hot water mode.
5.		<p>If hot water is not dispensed for more than 30 minutes heater will go off. If temperature went below 50 °C, HOT icon will go dim. Again, consumer need to touch and hold HOT icon for 3 seconds to turn ON heater.</p> <p>Note: When the water selection is in Hot temperature and need to change the setting to warm temperature then user need to first let the water temperature come down to less than 50 °C by discarding or waiting and re select temperature when option appears.</p>

Segment display will show water temperature.

ERRORS & THEIR DEFINITION

Type of faults, Indications & Error codes

INDICATION
ON CLOCK
DISPLAY

SE : 01



In case fault detected in UV lamp functioning then the indicator will blink & the buzzer will beep in every 10 seconds interval. Error code message "SE- 01" will appear clock display.

INDICATION
ON CLOCK
DISPLAY

SE : 02



In case fault detected in UV LED then the indicator will blink. Error code message "SE- 02" will appear in clock display.

INDICATION
ON CLOCK
DISPLAY

SE : 03



In case fault detected in Normal water dispense SV then the indicator will blink. Error code message "SE- 03" will appear in clock display.

INDICATION
ON CLOCK
DISPLAY

SE : 04



In case fault detected in RO pump / SV fault then the indicator will blink. Error code message "SE- 04" will appear in clock display.

INDICATION
ON CLOCK
DISPLAY

SE : 05



In case fault detected in Hot/Warm water dispense SV fault then the indicator will blink. Error code message "SE- 05" will appear in clock display.

INDICATION
ON CLOCK
DISPLAY

SE : 06



In case fault detected in PCB functioning then the indicator will blink. Error code message "SE- 06" will appear in clock display.

INDICATION
ON CLOCK
DISPLAY

SE : 07



In case fault detected in temperature sensor fault then the indicator will blink. Error code message "SE- 07" will appear in clock display.

INDICATION
ON CLOCK
DISPLAY

SE : 08



In case fault detected in Heater PCB fault then the indicator will blink. Error code message "SE- 08" will appear in clock display.

INDICATION
ON CLOCK
DISPLAY

SE : 09



SE : 09 In case fault detected in Heater Fault then the indicator will blink. Error code message "SE- 09" will appear in clock display.

CSL



Child safety lock. In child lock mode, if HOT icon is touched, 'CSL' message will be displayed. To come out of child safety lock mode, consumer has to touch and hold HOT and WARM icon all together for 3 seconds, then single beep will come indicating product entered to ready to dispense hot water mode.



In case of low pressure condition (Input water pressure is not adequate) then tank indication will blink

INSTALLATION INSTRUCTIONS

1. Open the carton and take out the following items from accessory kit for installation:
 - a. Diverter valve
 - b. Mounting plate with plastic inserts and mounting screws
 - c. PL 4 pipe-White and blue
2. Select an appropriate water connection point.
3. Please note water purifier is connected to ambient temperature water supply only.
4. Fix diverter valve with the help of pipe wrench/plumbing equipment's at selected water point.
5. For wall mounting: Align the mounting plate at appropriate height and fix it with the help of mounting screws. Hang the water purifier on mounting plate.

OR

Place the water purifier on counter top.

6. Fix the water inlet pipe (white pipe) from diverter valve to the feed water inlet port of water purifier and open the diverter valve. Ensure there is no leakage of water and bending of pipe at any point.
7. Outlet pipe (blue pipe) is connected to flushed water outlet port of purifier.
8. Fix the power plug into a 3 pin socket. It is advice to fix the product to the power supply that is provided with the purifier.
9. Switch ON the mains, unit will start working. Wait until the storage tank gets filled. Once tank is full Heater icons are enabled for selection. As per user requirement, to select warm/hot dispense option refer page no. 14.
10. It is advised to drain the first fill of water tank (use only the hot/warm dispensing option to drain) after installation of the water purifier or after changing the filters. This water can be used for washing, cleaning and other household purpose.

CAUTION:

Before installation/mounting:-Flush all filters and membrane thoroughly and independently for 3 minutes - 5 minutes to remove fine particles & preservatives present in filters.

Check input water pressure. Use booster pump if feed water is less than 0.04 MPa (6 psi) or pressure reducing valve if it is more than 0.21 MPa (30 psi), available at an additional cost. The appliance is intended to be permanently connected to the water mains and not connected by a hose-set.

The appliance is intended to be permanently connected to the water mains and not connected by a hose-set.

DO'S, DON'TS & SAFETY INSTRUCTIONS

DO'S ✓

Always install the water purifier in a cool, dry and well ventilated place in upright position.

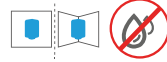

Keep the tank lid closed properly to avoid contamination of water due to exposure to dust, dirt or insects.



To keep your purifier functioning properly, always use Havells genuine spare parts.



Call Havells customer care for any assistance and service requirement.



Keep the purifier in power ON mode to ensure water availability at all times. System automatically shuts OFF when tank is full of purified water.



If for any reason you are not using the water purifier for a long time, for example during a holiday, then make sure first you turn off the input water supply and drain the storage tank & Hot water tank then turn off the power supply.



During preventive maintenance drain the hot water tank through drain plug. Ensure that disconnect power supply while drain the hot water tank.

If for any reason you are not using hot water for more than 48 hours, its advised to discard 1 litre stored water by faucet.

DON'TS ✗

Never connect your water purifier to hot water supply as it is designed to work effectively for input water supply between 5 °C to 45 °C temperature.



- * Never place any heavy, sharp or wet objects on the purifier.
- * Do not operate any electrical appliance with wet hands or while standing in water.

- * Do not make modifications to a cord's plug at any time.

* DO NOT fix or try to repair any component parts. If you find any wrong in your Gracia Water Purifier, Please call Havells Service to attend the machine for preventive maintenance.

In case of any break down do not buy local spares parts and components for service or replacement.



Do not install product in direct sunlight.



SAFETY INSTRUCTIONS

Havells Water Purifier is designed keeping in mind the highest safety standards, but there are certain safety precautions that need to be followed while using the product for its proper functioning.

Hot water is dangerous especially for children, Aged or disabled. Water temperature over 50 °C may cause severe burn due to scalding if touched with bare hand. Havells GRACIA ALKALINE MAX has in-built safety feature of CHILD SAFETY LOCK during Hot water dispensing.



Do not move or relocate the purifier when it is working.



To avoid electric shock, do not pull out or touch the power plug with wet hands.



Do not use the water purifier if the power cord is damaged or if there's a strange noise, burning smell or smoke. Quickly switch off the power, unplug the cord and call Havells Customer Care.



Don't open the purifier yourself to clean the cartridges or to replace any parts.



Never use the discarded water from the purifier for drinking. However it can be used for cleaning, washing, mopping, gardening etc.

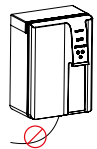

- This appliance is not intended for use by persons (including children) with reduced physical, sensory or mental capabilities, or lack of experience and knowledge, unless they have been given supervision or instruction concerning use of the appliance by a person responsible for their safety.
- Children should be supervised to ensure that they do not play with the appliance.
- * This appliance can be used by children aged from 8 years and above and persons with reduced physical, sensory or mental capabilities or lack of experience and knowledge if they have been given supervision or instruction concerning use of the appliance in a safe way and understand the hazards involved

CLEANING AND MAINTENANCE

Storage Tank of this product must be * periodically cleaned (at least once in 6 months, during Preventive service) by use of 4 drops - 5 drops of disinfectant like hypochlorite solution to water purifier tank (tank full), keep it for 15 minutes. Discard the disinfectant water and the first fill of water tank completely through water dispensing tap.

* As per customer need.



Use a wet cloth to clean the external body of the purifier. Do not use detergent or soap.



Avoid excessive rubbing of the decorative part of the purifier while cleaning as it may lead to scratches or loss of shine of the purifier.



Make sure you switch off the power supply and close the diverter valve whenever you're out of home for a long duration.



Do not try to open or tamper the purifier yourself if you observe any problem. Kindly contact Havells Customer Care to resolve the issue. Water purifier should be examined by Havells trained service engineer only.



Do not clean the water purifier or spill water on it, while the purification process is on.



RECOMMENDATIONS AND IMPORTANT INSTRUCTIONS



RECOMMENDED CARTRIDGE REPLACEMENT:

Membrane Performance Enhancer Cartridge, Sediment Cartridge, Activated Carbon Cartridge need to be replaced after 1 year of installation or after dispensing 6000 litre* of purified water, whichever is earlier.



RECOMMENDED CARTRIDGE REPLACEMENT:

As per the warranty, RO Membrane needs to be replaced after 1 year of installation or after dispensing 6000 litre* of purified water, whichever is earlier.



BACTERIOSTATIC ALKALINE TASTE ENHANCER

Bacteriostatic Alkaline taste enhancer Cartridge needs to be replaced after 1 year of installation or after dispensing of 6000 litre* of purified water, which is earlier.



GERMICIDAL UV COLUMN:

UV LAMP needs to be replaced after burning of 5000 hours or based on service requirement.



TANK UV LED:

UV LED needs to be replaced after burning of 5000 hours or based on service requirement.

Note: Please read the warranty details and their terms and conditions for replacement requirement of individual cartridges.

* May vary depending on the feed water quality.

HOW TO REUSE THE FLUSHED WATER

Although the flushed water from the purifier has slightly higher concentration of TDS and hardness but it is filtered and activated carbon treated tap water. It can still be used for following activities:

- for watering the plants
- for mopping and cleaning the floor
- to clean bathroom



TROUBLESHOOTING

	PROBLEMS	CHECKS	SOLUTIONS
Before calling Havells Customer Care or service engineer, check the following points: 1. Power supply should be ON 2. Inlet water supply should have sufficient pressure/ Waterflow	Purified Water taste is bad or unusual	1. Is the tank clean? 2. Is purified water being stored in the tank for a long time? 3. Is the Cartridge replacement due as per the service requirement?	1. Clean the storage tank. 2. Discard the water stored in tank and clean the tank before starting the purification process again. 3. Contact Havells Customer Care to request for the cartridge
	Purification time is very long/short or filtration has stopped.	1. Is the diverter valve open properly? 2. Is water pressure below recommended value? 3. One or more Cartridges may have been clogged or damaged.	1. Open the water inlet valve completely. 2. Contact Havells Customer Care to get the pressure checked and get it resolved. 3. Contact Havells Customer Care to get the cartridges replaced.
	Very less or no water is being flushed out.	1. Check if the flushed water pipe (Blue pipe) is bent anywhere. 2. Check if the flushed water pipe is blocked in any place.	1. Remove the bend in the flush water pipe if found. 2. Switch off the purifier and contact Havells Customer Care for proper checking the product.
	Water leakage in any part.	Check if water is dripping from purifier or connecting pipe.	Close the water inlet valve, unplug the power cord and then contact Havells Customer Care for a check-up of the product and get it rectified.
	No Hot / warm water	1. Check whether the storage tank is full. 2. Check whether the input water supply is on.	1. Open input water supply. 2. Contact Havells Customer Care.

FAQs

1. What is TDS?

TDS stands for Total Dissolved Solids in water. Beyond a level, this affects taste of water and beverages prepared with such water.

2. Does it have provision of hot water?

Yes HAVELLS GRACIA ALKALINE MAX have 3 option of water dispensing

* Hot water @ 80 °C

* Warm water @ 45 °C

* Ambient water @ room Temperature

3. Is the purification process completely automated or a manual intervention is required?

The purification process is completely automatic. Purification starts when water level in purified water tank goes down and stops once water tank is full.

4. How much time does it take to purify water in Havells Water purifier?

Havells Water Purifier (GRACIA ALKALINE MAX) can purify upto 15 litre of water per hour. However, time taken for purification depends on the feed water quality, input pressure and life of the cartridges.

5. How will I get service or spare parts for my water purifier?

During the first year of usage, your product is fully covered under the warranty and service will be on demand. Please contact Havells Customer Care for service visit to your place.

Post warranty period, you can opt for either of the following two service contracts available:

1. ACMC (Annual Comprehensive maintenance contract):

Under this contract electrical parts & service visit charges will be covered and the filters will be covered as mentioned below.

What covered: Two times Preventive Maintenance Visit ,One time replacement of All the filters, Electrical parts like Internal pump, PCB, Hot water tank, UV lamp, Wiring harness, & Solenoid Valve

What not covered: Plastic parts

2. SCMC (Semi Comprehensive maintenance contract):

Under this contract the consumables like filters will be covered except RO membrane as mentioned below.

What Covered: Two times Preventive Maintenance Visit ,One time replacement of All the filters Except RO Membrane, Electrical parts like Internal pump, PCB, Hot water tank, UV lamp, Wiring harness, & Solenoid Valve.

What not covered: RO membrane & plastic parts.

WARRANTY TERMS AND CONDITIONS

Havells India Ltd (HIL) offers limited warranty for this water purifier against defect arising from faulty design, workmanship and material subject to the following terms and conditions:

1. All electric and functional parts are covered under warranty for 1 year from the date of purchase.
2. Consumables including Membrane Performance Enhancer, sediment cartridge, activated carbon cartridge, RO membrane, Bacteriostatic Alkaline taste enhancer are not covered under warranty.
3. All consumables and pump carry Havells branded embedded foil (as per Recommendation & important instruction mentioned in content no.16)
4. Havells India Limited will offer two preventive maintenance checkups during this one year term of warranty. Only Havells India Limited authorized service personnel will carry out repairs under warranty.
5. Consumers shall promptly notify the company about any defect noticed and give the company or authorized personnel/representative adequate opportunity to inspect, test and rectify the defect.
6. The company or its representatives are entitled to retain the damaged or defective parts replaced under warranty on free charge basis.
7. The company's liability under warranty will be limited only to the concerned product and its defect, which occur under conditions of normal operations in home application, under proper usage and maintenance. It excludes any defect caused due to faulty care, maintenance, repair and alteration to the product or to its part by unauthorized personnel.
8. It is mandatory to provide original bill/invoice copy along with duly stamped warranty card at the time of any repair work being done by authorized representative.
9. This warranty is confined to the first purchase of the product only and is not transferable.
10. In the event of repair during the warranty period of the purifier, this warranty will thereafter continue and remain in force only for the unexpired period of the warranty. Replacement of part would be purely at the discretion of Havells India Limited, the same part will be replaced with the part model of price equivalent at the time of purchase.
11. The consumer will have no claim under this warranty in an event of any illness, sickness, death, personal injury, property or consequential damages arising either directly or indirectly due to utilization of product. Authorised Service Personnel will carry out repair under warranty.
12. Warranty is not applicable and will be void under the following heads/ circumstances:
 - a. If the warranty card presented to authorized service personnel at the time of service of the product is not duly filled and stamped by the dealer.
 - b. If the product is not operated or handled as per instruction given in the operating instruction booklet.
 - c. If the device is not installed in proper procedure specified.
 - d. If any defect caused due to improper electric circuit outside the device in the house or any defective electric supply.
 - e. If installation and any repair work is carried out by an unauthorized personnel and usage of consumables and parts by unauthorized personnel. (only Havells India Limited Authorised Service Personnel will carry out repair under warranty)
 - f. If any damage caused due to transportation or shifting post installation from consumer's home.
 - g. If 12 months have expired from the date of purchase even though the device is not in use for anytime during warranty period for any reason.

- h. If the damage is caused by pest infestation.
 - i. If product/item is not installed by company technician/ Authorised Personnel
 - j. If Havells water purifier is used for any purpose other than for home application purpose (not to be used for commercial purposes)
 - k. If damage to the product is caused by accidents, pests and vermin, lightning, wind, fire, floods, or acts of God
 - l. If any additional accessories were provided on the time of installation/service, the same will not be covered under standard product warranty.
 - m. If any external accessories supplied by the dealer.
13. Warranty does not cover visitation charges of service technician if this water purifier is installed beyond municipal limits of the city in which company's Authorized Service Center is situated/ located. All expenses incurred in collecting the units or parts there of from the company's authorized service center as well as expenses incurred from deputizing service personnel/ technicians for conveyance and other incidentals, etc., shall be borne by the customer. Local charges for transportation and handling charges may vary by location. Customers are advised to verify in advance the aforementioned charges. If the customer wishes to bring the unit on his/ her own to an authorized service center, such shall be at his/her own risks & consequences.
 14. Reinstallation or uninstallation of product based on customer demand and packing material, if used, will be chargeable.
 15. Warranty will not cover transportation cost in case customer is moving the product to another location.
 16. In case of any unpredicted situation and non -availability of spares, prevailing depreciation policy of Havells India Limited (subject to the sole discretion of Havells India Limited, may be changed without prior notice) will be applied to the product as a solution.
 17. Settlement of all claims and disputes arising out of and in relation to this water purifier shall be subject to Delhi jurisdiction only.
 18. The company or its Authorized Service Center reserves the right to retain any part or component replaced at its discretion in case of a defect discovered in the equipment during the warranty period.
 19. The warranty is valid within India only.

10 YEAR Stainless Steel Tank WARRANTY*

***(1-year Standard Warranty + Additional 9 years Stainless Steel Tank Warranty)**

*Warranty on Rusting of Stainless-Steel Tank

* Additional 9-year Warranty on Stainless – Steel Tank after completion of 1 year Standard Warranty

* No accidental damages will be covered

* No other parts will be covered other than the Stainless-Steel Tank

* Service charges to be payable by customer after 1 year Standard Warranty



We are an environment conscious company and have started an initiative to dispose the product wastes like replaced parts and filters in an environment friendly manner. You are advised to handover the replaced parts and discarded filters to our service engineers and we will ensure that these parts are disposed of without causing any harm to the environment.

Diagrams or figures in this document are for illustration purposes only.

Copyright Subsists. Imitation of trade dress, graphics and color scheme of this document is a punishable offence.

Actual products may vary in colour, design, description and colour combination etc. Although every effort has been made to ensure accuracy in the compilation of the technical detail within this publication, Specifications & performance data are constantly changing.

050923/V1

Havells India Ltd.

QRG Tower, 2D, Sector-126, Expressway,
Noida - 201304. U.P. (INDIA)

E-mail: customercare@havells.com,
Website: www.havells.com

Customer Care No.: 08045 77 1313
WhatsApp No.: +91-9711773333

Join us on Facebook at www.facebook.com/havells & share your ways to save the planet!



**WARRANTY CARD
HAVELLS WATER PURIFIER**

Customer Name _____

Customer Address _____

Customer Phone Number _____

Pin Code _____

Date of Purchase _____

Dealer's Name & Address
Phone Number

Dealer's Stamp:

Product Model _____

Product Serial No. _____

* This warranty card is valid only for products sold by Havells India Limited in Indian market.
This warranty is not transferable and is applicable to the original purchaser only.



Fill out this record and keep it together with your purchase docket in a safe place. Should you require service under the terms of this warranty, please contact us.

Havells India Ltd.

QRG Tower, 2D, Sector-126, Expressway, Noida - 201304. U.P. (INDIA)

E-mail: customercare@havells.com, Website: www.havells.com

Customer Care No.: 08045 77 1313, WhatsApp No.: +91-9711773333

Join us on Facebook at www.facebook.com/havells & share your ways to save the planet!